

TRACTO

GRUNDOCRACK
DYNAMIC
RENOVATORS

Further Information
on GRUNDOCRACK

[TRACTO.COM/GRUNDOCRACK](https://tracto.com/grundocrack)



ADVANCED TRENCHLESS TECHNOLOGY

GRUNDOCRACK

DYNAMIC PRODUCTIVITY

The air-driven GRUNDOCRACK machine drives through the old pipe, breaking it up and spreading the fragments radially into the surrounding soil. At the same time, the pipe channel is widened and the new pipe is pulled in. The pulling force of a winch supports the pipe cracker, guaranteeing safe guidance through the given pipe path. All GRUNDOCRACK machines are equipped with a reverse gear, allowing for the accessories to be disassembled quickly and ergonomically and the machines to be easily recovered, even in confined spaces.

GRUNDOCRACK
Application
Videos at



TRACTO.COM/
APPLICATIONS

APPLICATION

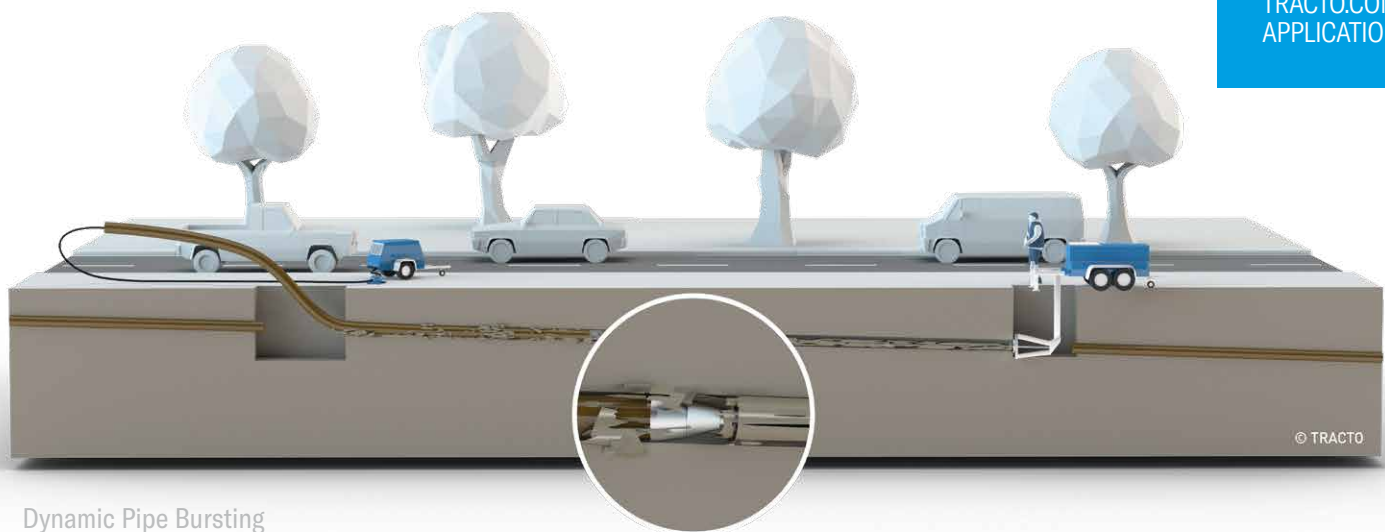

Dynamic Pipe Bursting

METHOD



STATIC

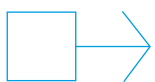

DYNAMIC

OUTER DIAMETER NEW PIPE

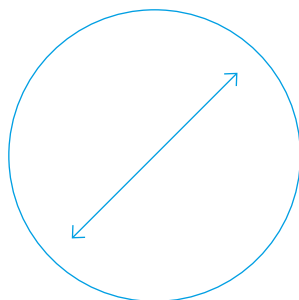

225 – 560 MM*

*depending on machine type

MAIN APPLICATIONS

**RENEWAL
PRESSURE
PIPES***

**RENEWAL
GRAVITY
PIPES***

* Gas, sewage

SPECIAL APPLICATIONS

**RENOVATION
PRESSURE
PIPES***

**RENOVATION
PRESSURE
PIPES***

OVERVIEW

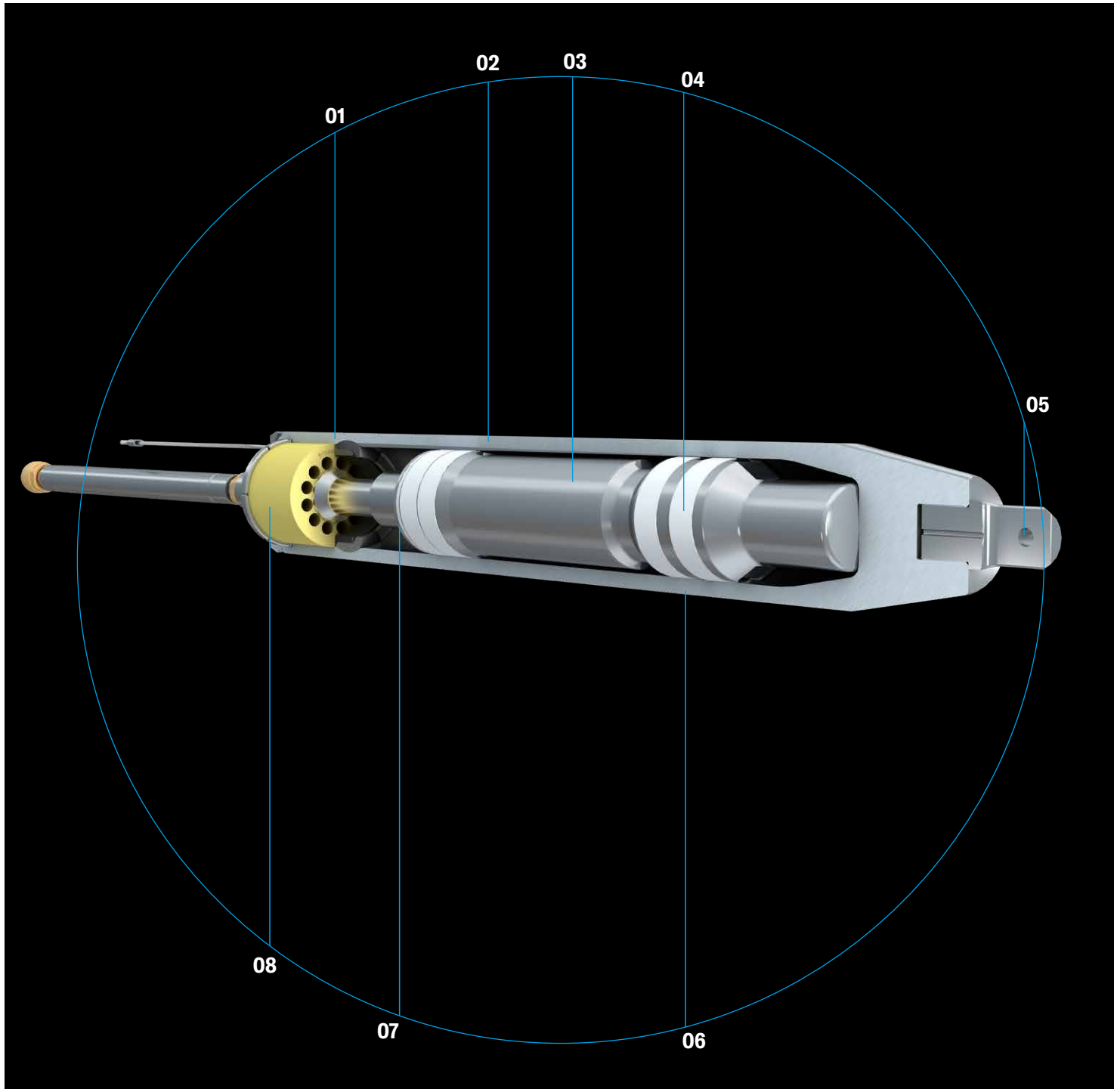

01 Inner and outer chrome-plated casing to increase the corrosion resistance and reduce wear and tear

02 Solid, one-piece casing – heavy-duty without welded seams or screwed joints

03 Solid, hardened and tempered piston for increased strength and longer service life

04 Piston slide tapes prevent friction between piston and casing and reduce wear and tear

05 Pulling eye for cable connection for a target-precise guidance of the cracker

06 Smooth machine casing – easy retrieval through the new pipe in confined working conditions

07 Piston seals minimise the air consumption and therefore increase the performance and efficiency

08 Elastically mounted control stud – gentle on material

GRUNDOCRACK

DYNAMIC PIPE RENEWAL

With dynamic pipe renewal using the bursting method, damaged old pipes made of stoneware, asbestos and fibre cement, grey cast iron, PVC or concrete are broken up and simultaneously replaced with new pipes made of HDPE (long or short pipes) or PVC-U (short pipes) of the same or even larger nominal diameter.

The pipe bursting method is used when the function of the old pipe is impaired, e.g. misalignment, cracks, missing base or partial collapse, or when repair/renovation is no longer possible. The method is also suitable for pipes with a need for capacity increase or when a new pipe with a higher wear reserve is required.

GRUNDOCRACK
Application
Videos at



[TRACTO.COM/
APPLICATIONS](https://tracto.com/applications)

APPLICATION

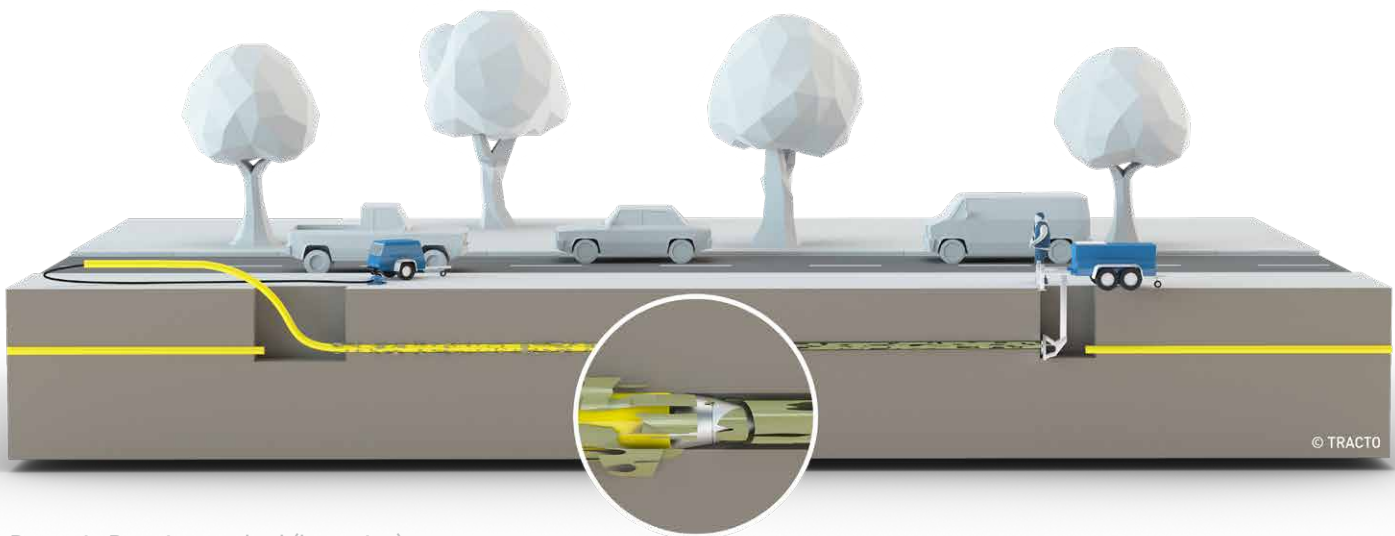

Dynamic Bursting method (long pipe)

© TRACTO



GRUNDOCRACK SIMPLY GOOD

Reverse gear / Servo control

With the easy-to-handle servo control, you can switch over from forward into reverse gear by simply throwing the lever.



From one piece

The solid casing consists of only one piece, manufactured from a single forged part and then galvanised. Due to precise deep hole boring, the piston impact makes its way to the head of the machine, effecting direct force transmission.

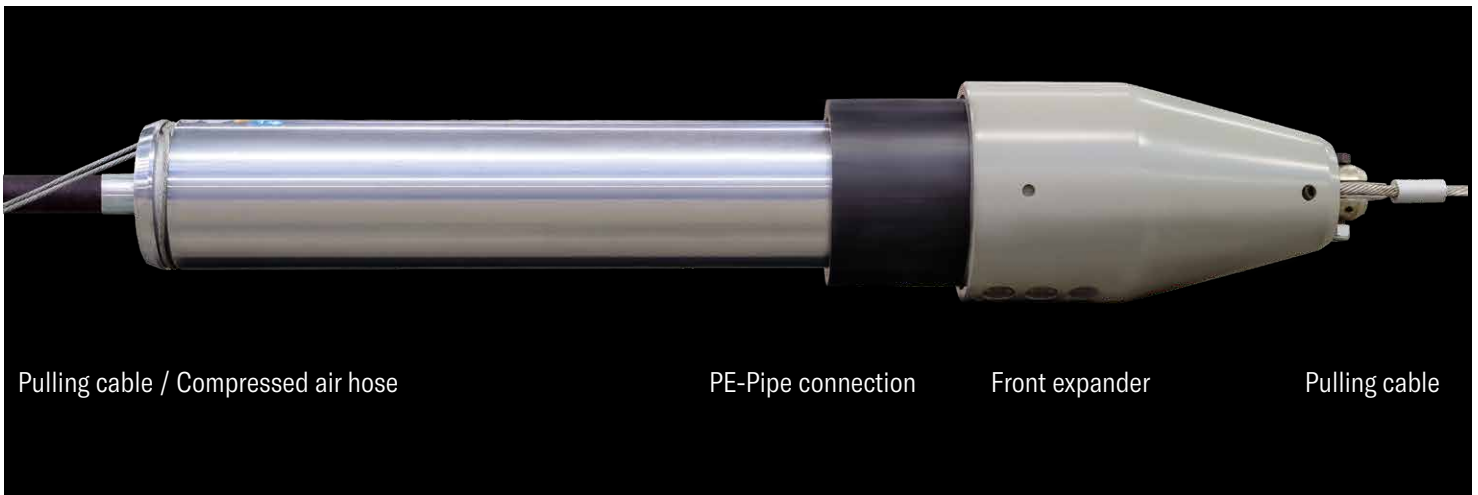
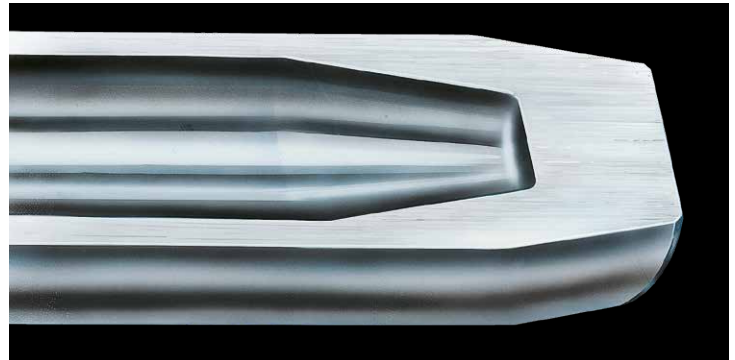

Pulling cable / Compressed air hose

PE-Pipe connection

Front expander

Pulling cable

VARIATIONS

GRUNDOCRACK



- Heavy-duty one-piece casing – without seams or screwed fittings
- Smooth machine casing – simple retrieval of the machine through the new pipe in limited space
- Reverse gear with servo-control – easy release of the cracking tools with ergonomic handling
- Pulling eye for cable connection – target-precise guidance of the cracker
- Front cone – direct/optimal power transmission to the expander
- Elastically mounted control stud – minimal wear even under high load

TECHNICAL DATA

GRUNDOCRACK-TYP	PCG 130	PCG 180	PCG 200	PCG 260	PCG 350
Machine-Ø	130 mm	180 mm	208 mm	280 mm	380 mm
Length (mm)	1,460 mm	1,700 mm	2,100 mm	2,290 mm	2,730 mm
Weight (kg)	95 kg	230 kg	395 kg	615 kg	1,180 kg
Expander-Ø (mm)	280 mm	392 mm	450 mm	560 mm	630 mm
New pipe puter-Ø (mm)	225 mm	315 mm	355 mm	450 mm	560 mm
No. of strokes	320 min ⁻¹	280 min ⁻¹	290 min ⁻¹	310 min ⁻¹	220 min ⁻¹
Air consumption (m ³ /min)	2.7 m ³ /min	4.5 m ³ /min	6.5 m ³ /min	12 m ³ /min	20 m ³ /min
With blade head	x	x			
With pulling eye		x	x	x	x

All data without guarantee

ACCESSORIES

GRUNDOCRACK PERFECTLY EQUIPPED

For adpation to different soil conditions and pipe materials, we offer a wide range of custom-fit accessories for pipe renewal.

SMOOTH EXPANDER



EXPANDER WITH CUTTING BLADES



SHORT PIPE TENSIONING DEVICE



Spannfix with pulling cable

7L-OIL LUBRICATOR



Installed between the compressor and the machine to lubricate the internal piston.

FRONT EXPANDER



GRUNDOCRACK with smooth front expander and PE pipe connector long pipes

REAR EXPANDER



GRUNDOCRACK with rear expander, cutting blades and PE pipe connector long pipes

APPLICATION

APPLICATION

PIT - PIT

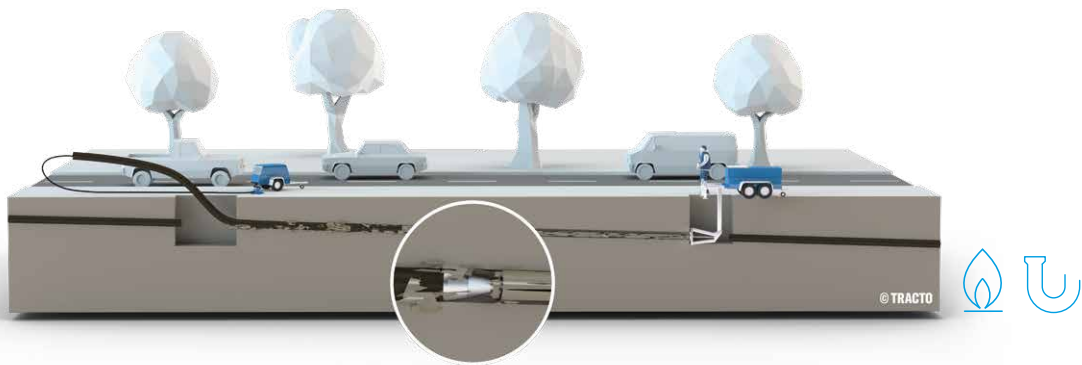

PIT - MANHOLE



APPLICATION

MANHOLE- MANHOLE

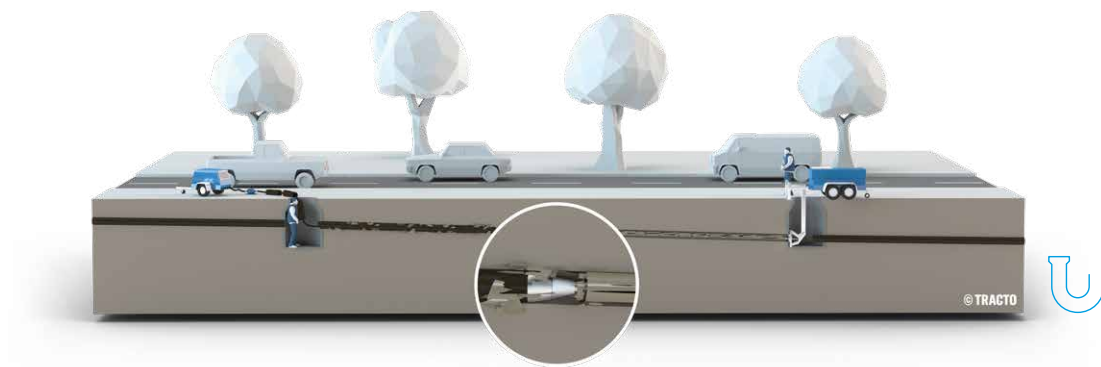

Method	Dynamic pipe bursting
Bursting lengths	Max. 300 m
Pipe diameter	Up to 508 mm
Old pipes made of	Concrete, steel reinforced concrete, stoneware, grey cast iron, PVC, asbestos cement, fibre cement
New pipes made of	PE/PP, PVC
Soil classes	Old pipe passable for cable pull

FULL SERVICE FOR TRENCHLESS TECHNOLOGY

Whether its before, during or after the purchase, whether in person or online – we are always at your side with advice and support. Our wide-ranged service is specially tailored to the requirements of trenchless pipe installations, so you can concentrate fully on your core business.

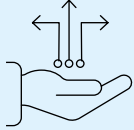

Digital Solutions

Our website offers you the whole world of trenchless technology in digital form. Find out more about our company, our products and their applications. Discover the digital tools for the HDD drilling technology and many other intelligent solutions. Always stay up to date by using the links to our social media channels. Or you can order machines, accessories and spare parts in our eSHOP – easy and conveniently via PC, smartphone or tablet.

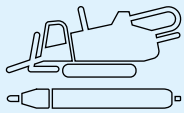

Nodig Product Specialists

You can truly rely on our product specialists for all technical questions regarding the function and application of our steerable and non-steerable NODIG-systems. With comprehensive knowledge in each of their special fields, you can be sure they will find the best solution for your trenchless projects and advise you competently on setting up your jobsite.



Financing

We offer attractive financing solutions for new and used machines to our customers and sales partners through the TRACTO-TECHNIK Finance GmbH. Be it financing, hire purchase, various types of leasing or insurance: we provide extensive expert advice, individually and personally, in order to find the tailored solution for you. Discretion goes without saying.



Training

Qualified training enables you to apply trenchless technology even more effectively and profitably. Our wide range of training courses for machine operators, construction professionals as well as planners and clients cover all aspects of NODIG technology, including special topics. Certified trainers also instruct you, in theory and practice according to your individual requirements, either at one of our numerous company locations, or directly on your own premises or online, independent of time and place.

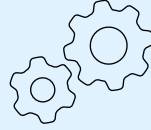

Specialised Civil Engineering Service (Application Technology)

The specialised civil engineering service for application technology provides support for all your trenchless construction sites. Our experts demonstrate the steerable and non-steerable NODIG technology live in practical use, show your drilling teams how to use it or actively assist with special projects.



Geoservice

Precise knowledge of the soil is the key to successful trenchless projects. Our Geoservice team provides you with this professional knowledge. Our expertise puts you in a position to master every type of soil. Based on geoscientific maps and existing construction files, we supply information on the soil, which will help you with calculations or supplements.



Used Equipment

If you want to sell a used machine at an attractive price or are looking for the right equipment for your tasks, our full service for used NODIG machines will take the workload off your hands – from appraisal and price determination to professional repair and certification, through to achieving the best price for you via our used machine website with access to one of the world's largest construction machinery platforms.

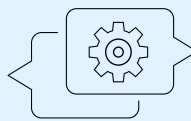

After Sales

Via our worldwide service network we are always there for you, even after the purchase. A total of five TRACTO plants and seven customer centres in Germany, as well as our worldwide sister companies and sales partners guarantee fast supply of spare parts and immediate availability. Our competent service staff offer fast assistance, to ensure you don't lose any time.

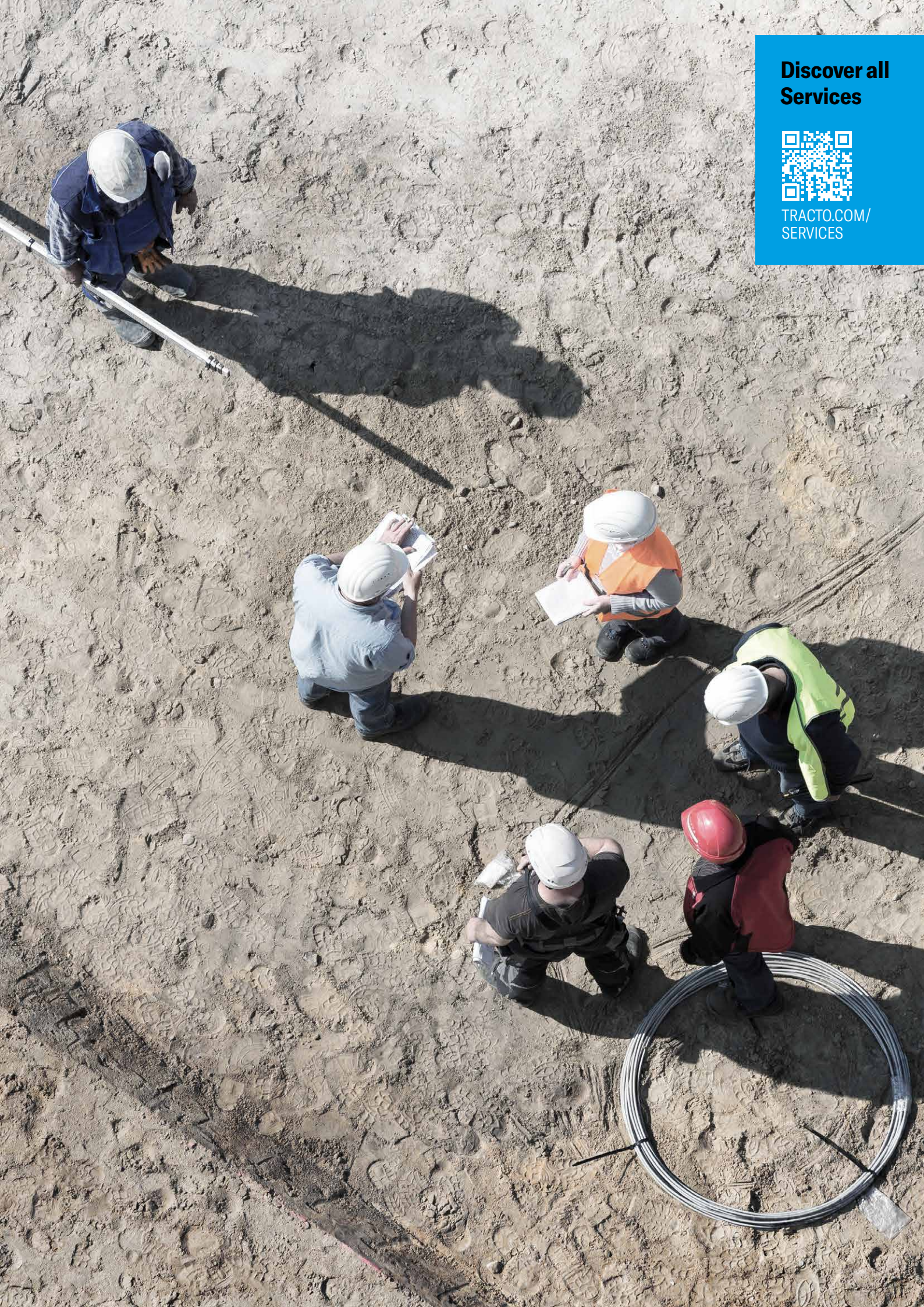

**Discover all
Services**



[TRACTO.COM/
SERVICES](https://tracto.com/services)

TRACTO-TECHNIK GMBH & CO. KG HEADQUARTERS

PAUL-SCHMIDT-STRASSE 2
57368 LENNESTADT, GERMANY
T +49 2723 808-0
F +49 2723 808-180
INFO@TRACTO.COM
TRACTO.COM/DE



TRACTO.COM



- TRACTO HEADQUARTERS
- TRACTO SISTER COMPANIES
- TRACTO DISTRIBUTORS

SWITZERLAND
TRACTO-TECHNIK SCHWEIZ AG
INDUSTRIESTRASSE 4
8360 ESCHLIKON TG, SCHWEIZ
T +41 79 8203897
CH@TRACTO.COM
TRACTO.COM/CH-FR

UNITED KINGDOM
TRACTO-TECHNIK UK LTD
10 WINDSOR ROAD
BEDFORD MK 42 9SU
T +44 1234 342566
F +44 1234 352184
INFO@TRACTO-TECHNIK.CO.UK
TRACTO.COM/UK

FRANCE
TRACTO-TECHNIK FRANCE S.A.R.L.
1/3 RUE DE LA PRAIRIE
F-77700 BAILLY ROMAINVILLIERS
T +33 1 60 42 49 40
F +33 1 60 42 49 43
FR@TRACTO.COM
TRACTO.COM/FR

USA
TT TECHNOLOGIES INC.
2020 EAST NEW YORK STREET
AURORA, IL. 60502
T +1 630 851 8200
F +1 630 851 8299
INFO@TTTECHNOLOGIES.COM
TTTECHNOLOGIES.COM

AUSTRALIA
TRACTO-TECHNIK AUSTRALIA PTY LTD.
10 ALICIAJAY CIRCUIT
LUSCOMBE, QLD 4207
T +61 7 3420 5455
AU@TRACTO.COM
TRACTO.COM/AU

MOROCCO
TRACTO-TECHNIK AFRIQUE S.A.R.L.
ROUTE DE TAMESNA 4022
POSTE 2044, 12220 TAMESNA
T +212 5 37 40 13 63 / 64
F +212 5 37 40 13 65
INFO@TRACTO-TECHNIK.MA
TRACTO.COM/MA

TRACTO ADVANCED TRENCHLESS TECHNOLOGY

TRACTO PARTNER:

Images, text and graphics subject to change. Some of the product or service designations listed below as well as depicted logos are registered trademarks of TRACTO and in these cases are subject to the respective applicable trademark law.